

SMD Power Inductor CD54/T125



Description

- Ferrite drum core construction.
- Magnetically unshielded.
- L × W × H: 6.1 × 5.5 × 4.85mm Max.
- Product weight 0.4g(Ref.)
- Moisture Sensitivity Level: 1
- RoHS compliance.
- Qualification to AEC-Q200.

Dimension - [mm]

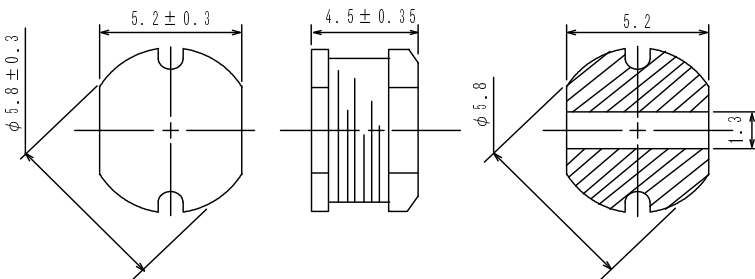

Environmental Data

- Operating temperature range: -40°C ~ +125°C (including coil's self temperature rise)
- Storage temperature range: -40°C ~ +125°C
- Solder reflow temperature: 260 °C peak.

Packaging

- Carrier tape and reel packaging.
- 13.0" diameter reel
- 1500pcs per reel

Land pattern and Schematics - [mm]

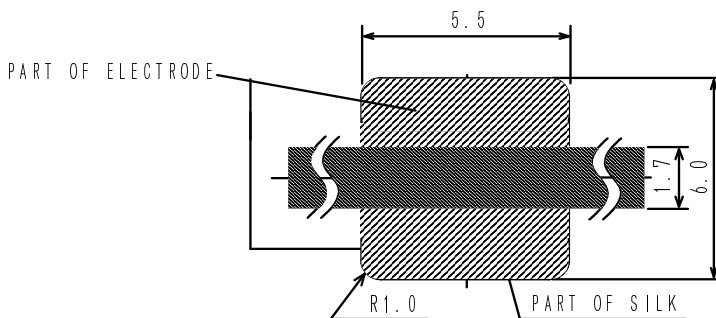

Applications

- Automotive and other high temperature, high reliability application.

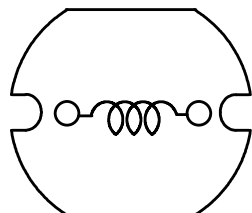

SMD Power Inductor CD54/T125



Electrical Characteristics

Part No.	Stamp	Inductance [Within] ※1	D.C.R. (Ω) (Max.) (at 20°C)	Saturation current (A) ※2	Temperature rise current (A) ※3
CD54T125NP-100MC	100	10 μ H \pm 20%	0.10	1.94	2.55
CD54T125NP-120MC	120	12 μ H \pm 20%	0.12	1.82	2.45
CD54T125NP-150MC	150	15 μ H \pm 20%	0.14	1.58	2.15
CD54T125NP-180MC	180	18 μ H \pm 20%	0.15	1.49	1.93
CD54T125NP-220MC	220	22 μ H \pm 20%	0.18	1.44	1.75
CD54T125NP-270MC	270	27 μ H \pm 20%	0.20	1.28	1.65
CD54T125NP-330LC	330	33 μ H \pm 15%	0.23	1.16	1.47
CD54T125NP-390LC	390	39 μ H \pm 15%	0.32	1.02	1.27
CD54T125NP-470LC	470	47 μ H \pm 15%	0.37	0.91	1.21
CD54T125NP-560KC	560	56 μ H \pm 10%	0.42	0.88	1.15
CD54T125NP-680KC	680	68 μ H \pm 10%	0.46	0.80	1.12
CD54T125NP-820KC	820	82 μ H \pm 10%	0.60	0.71	0.97
CD54T125NP-101KC	101	100 μ H \pm 10%	0.70	0.65	0.77
CD54T125NP-121KC	121	120 μ H \pm 10%	0.93	0.60	0.74
CD54T125NP-151KC	151	150 μ H \pm 10%	1.10	0.55	0.72
CD54T125NP-181KC	181	180 μ H \pm 10%	1.38	0.50	0.61
CD54T125NP-221KC	221	220 μ H \pm 10%	1.57	0.45	0.59

※1 Measured frequency Inductance 10 μ H \sim 82 μ H ; at 2.52 MHz
100 μ H \sim 220 μ H ; at 1 kHz

※2 Saturation current: This indicates the actual value of D.C. current when the inductance becomes 10% lower than its initial value($T_a=20^\circ\text{C}$).

※3 Temperature rise current: The actual value of D.C. current when the temperature of coil becomes $\Delta T=40^\circ\text{C}$ ($T_a=20^\circ\text{C}$).

SMD Power Inductor CD54/T125

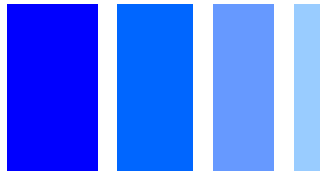

Saturation Current & Temperature Rise Graph

— L (20°C) — L (105°C) — ΔT

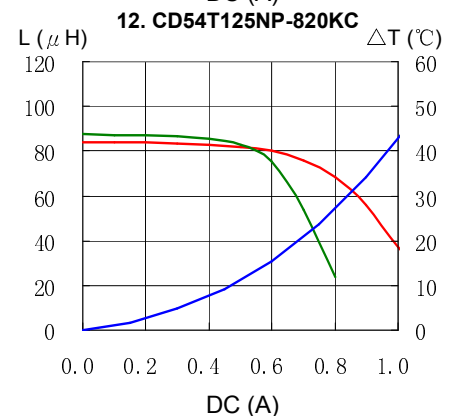
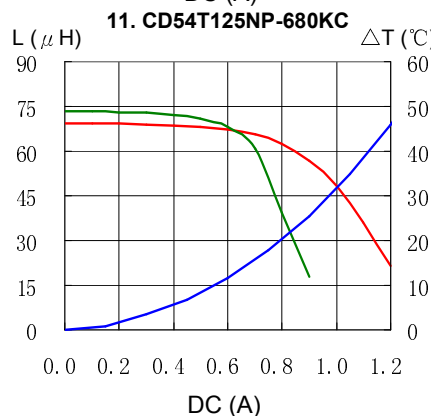
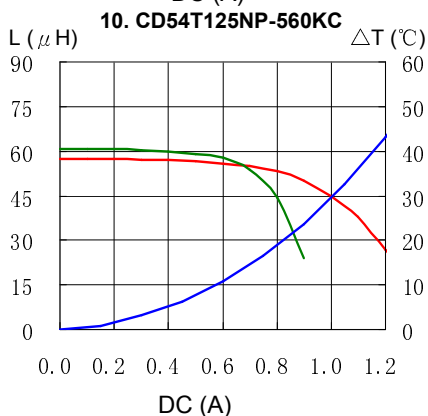
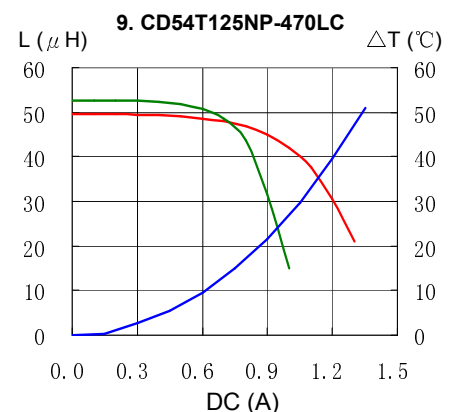
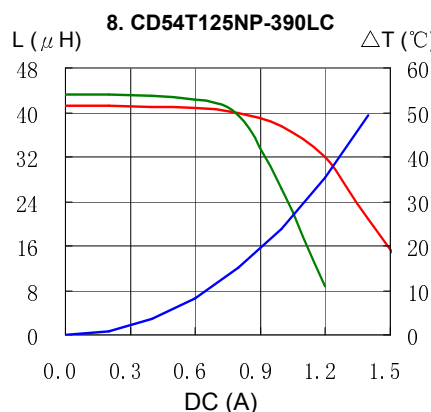
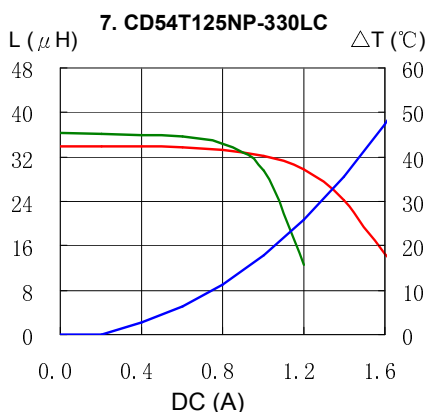
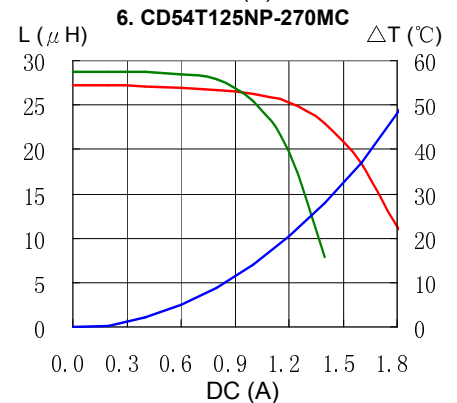
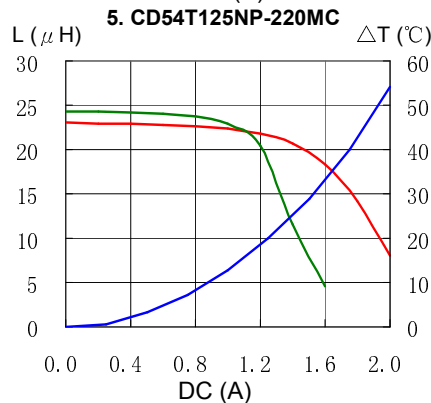
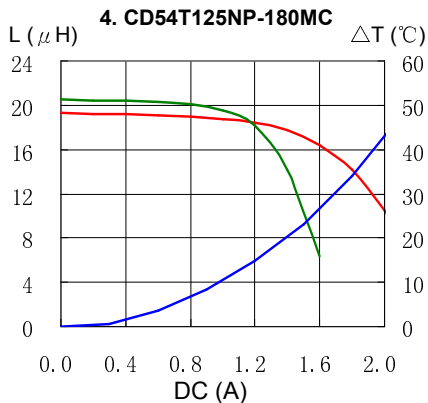
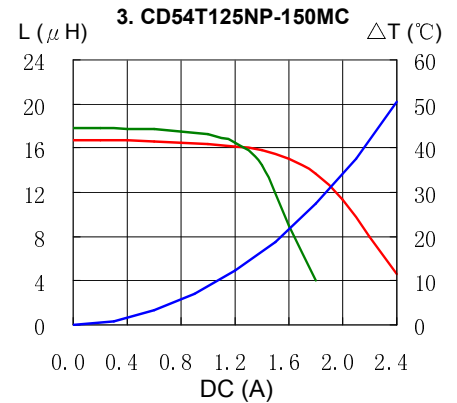
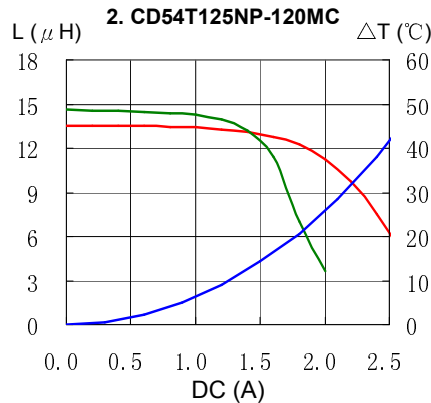
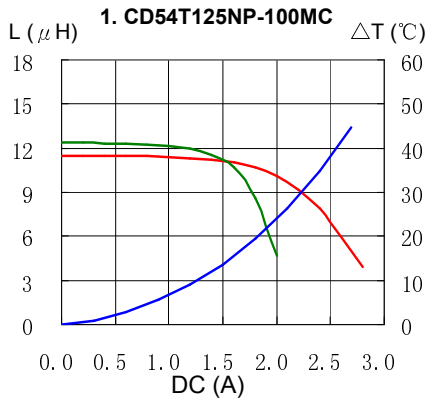

SMD Power Inductor CD54/T125



Saturation Current & Temperature Rise Graph

— L (20°C) — L (105°C) — ΔT

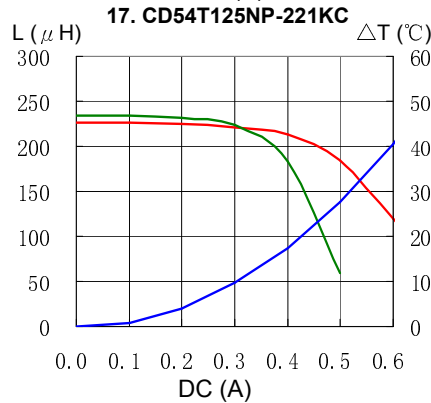
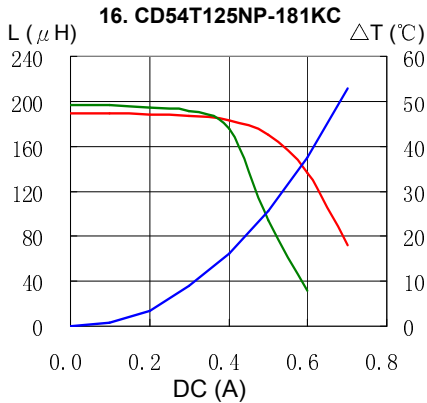
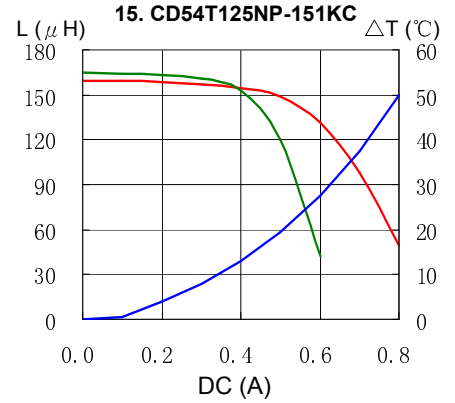
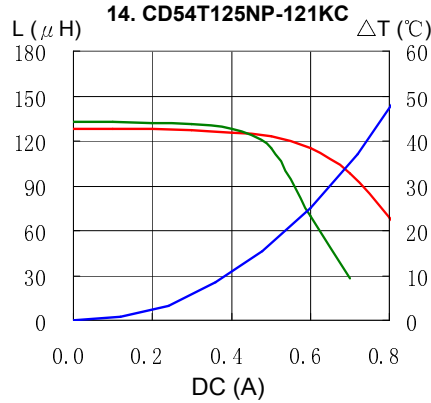
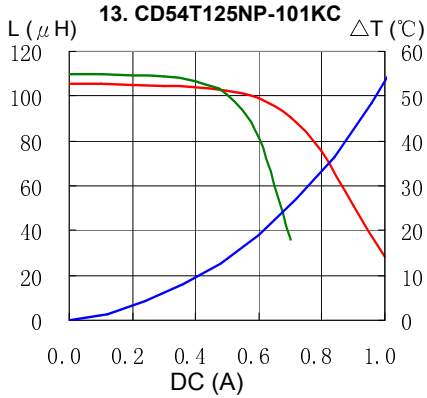

Solder Reflow Condition

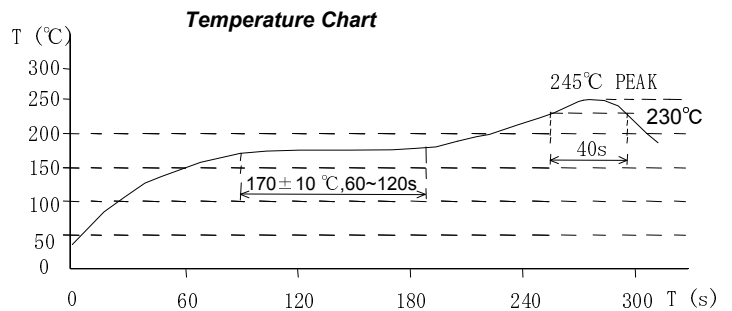
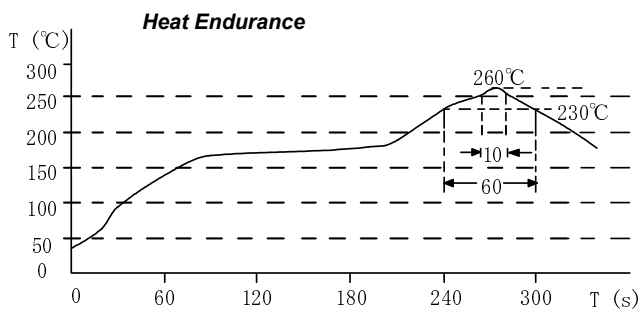

Please refer to the sales offices on our website - <http://www.sumida.com>

Hong Kong
Tel.+852-2880-6781
FAX.+852-2565-9600
sales@hk.sumida.com

Saitama(Japan)
Tel.+81-48-691-7300
FAX.+81-48-691-7340
sales@jp.sumida.com

Chicago
Tel.+1-847-545-6700
FAX. +1-847-545-6720
sales@us.sumida.com

Shanghai
Tel.+86-21-5836-3299
FAX.+86-21-5836-3266
shanghai.sales@cn.sumida.com

Seoul
Tel.+82-2-6237-0777
FAX.+82-2-6237-0778
sales@kr.sumida.com

Oberzell
Tel.+49-8591-937-0
FAX. +49-8591-937-103
contact@eu.sumida.com

Shenzhen
Tel.+86-755-8291-0228
FAX.+86-755-8291-0338
shenzhen.sales@cn.sumida.com

Singapore
Tel.+65-6296-3388
FAX.+65-6841-4426
sales@sg.sumida.com

Neumarkt
Tel.+49-9181-4509-110
FAX. +49-9181-4509-310
infocomp@eu.sumida.com

Taipei
Tel.+886-2-8751-2737
FAX.+886-2-8751-2738
sales@tw.sumida.com

San Jose
Tel.+1-408-321-9660
FAX.+1-408-321-9308
sales@us.sumida.com